

OSTARZ™



BT-Q1200

SOLAR Travel Recorder

Super 99[®] Bluetooth GPS Travel Recorder

Superior 51-Channel Performance with 48 hours NAV/LOG time



Table of Contents

1. OVERVIEW	2
2. PRODUCT NOTICE	2
3. FEATURES	3
4. PRODUCT SPECIFICATION	4
5. HARDWARE INTRODUCTION	5
5-1. APPEARANCE.....	5
5-2. HARDWARE FUNCTION.....	5
5-3. BATTERY INSTALLATION	6
5-4. LED INDICATORS	8
5-5. FUNCTION OF AUTO ON-OFF (POWER SAVING MODE).....	9
6. SETUP BT-Q1200	9
6-1. INSTALL USB DRIVER	9
6-2. INSTALL THE SOFTWARE UTILITY FOR BT-Q1200.	10
6-3. INSTALL GOOGLE EARTH.....	14
7. START TO USE	14
7-1. FULLY CHARGE THE BATTERY WHEN USING AT THE FIRST TIME	14
7-2. CONNECT BT-Q1200 WITH YOUR PC.....	14
7-3. START THE SOFTWARE UTILITY.....	15
8. USEFUL REFERENCE APPLICATIONS ON THE INTERNET	37
8-1. LOCR GPS PHOTO	37
8-2. GPSBABEL	38
8-3. SPORTSMATE	39
9. TROUBLE SHOOTING	42
10. APPENDIX	43
10-1. ACTIVATE THE BLUETOOTH FUNCTION IN YOUR PDA/SMART PHONE OR PC.....	43
10-2. CREATE BLUETOOTH SETTING (WINDOWS MOBILE 5 FOR POCKET PC)	44
10-3. START YOUR NAVIGATION SOFTWARE.....	49
10-4. SAFETY NOTICES	50

1. Overview

Thank you for choosing Qstarz Super 99[®] **BT-Q1200** - Bluetooth Solar GPS Travel Recorder, built-in new generation GPS chipset MTK with 51 channels performance for your navigation and travel log, and also, provides stand-alone logging up to 200,000 records with 48 hrs recording under sufficient sunlight, and supports Smart Power control for power saving to extend usage time even more. Besides, **BT-Q1200** software utility supports multi-condition setting which allows you to customize and personal travel record by 3-level detail adjustment and provides download, save, and split to arrange tracking record; moreover, you can display travel path directly on Google Earth and combine geography information with photos by Geotagging.

2. Product Notice

- Please take out the battery and store it in dry/cool places when not use for a long period.
- If BT-Q1200 isn't used in temperature between -10°C ~ 60°C , its battery charging capability will decrease. Leave the BT-Q1200 far from heat or high temperature environment. And also, do not expose your BT-Q1200 in temperature higher than $140^{\circ}\text{F}/60^{\circ}\text{C}$ to prevent the battery inside BT-Q1200 from overheating, exploding or burning itself. The Lithium battery inside the BT-Q1200 should be recycled.
- It is recommended to turn BT-Q1200 off in the hospital. Wireless GPS receiver may interfere with the medical equipments which use radio frequency.
- The manufacturer assumes no responsibility for any damages and loss resulting from the use of this manual, or from deletion of data as a result of malfunction, dead battery, or from misuse of the product in any way.
- Please clean the unit with a dry and clean soft close. Do not use harsh cleaning solvents, chemicals, alcohol, or strong detergents.
- Do not attempt to open BT-Q1200 by yourself. Unauthorized hacking may damage the unit, and void your warranty.

3. Features

- Super 99® Bluetooth GPS Travel Recorder with 51ch performance and 48hrs navigation time (*1)
- Adopt MTK chipset with high sensitivity -158dBm with fast FFTT
- The innovative GPS Travel Recorder to adopt solar panel with the slim type designed
- Dual Power Supply - Built in rechargeable Li-Ion battery & Solar power
- Support “One Touch” to turn On/Off LOG mode
- Stand-Alone travel recorder to log up to 200,000 records (*2)
- Provide PC utility with friendly UI and Multi-Language
- Support Multi-Mode setting to record data Vehicle, Bicycle, Jog)
- Draw your navigation path immediately on Google Earth as default
- Support GeoTagging function for digit photo and generate KMZ file easily
- Active NMEA protocol VTG / GLL manually via Qstarz setup tool
- Save the travel records as GPX / PLT / CSV / NMEA / Google Earth file format
- Support WAAS+EGNOS+MSAS
- Auto On-Off function for smart power control
- Personal/Portable Navigation (PDA, Smartphone, PC, etc.)

*1 BT-Q1200 can be extended up to 48 hours usage under enough sunlight (24 days usage with 2 hours navi per day)

*2 The waypoints would be decreased when the more options of Log Format are selected

4. Product Specification

General	
GPS Chip	MTK GPS Module
Frequency	L1, 1575.42MHz
C/A Code	1.023MHz chip rate
Channels	51-CH Performance
Antenna (Internal)	Built-in patch antenna with LNA
Sensitivity	Tracking -158dBm
Datum	WGS84
Performance Characteristic	
Position	Without aid: 3.0m 2D-RMS
Accuracy	<3m CEP(50%) without SA (horizontal) DGPS (WAAS, ENGOS, MSAS): 2.5m
Velocity	Without aid: 0.1m/s, DGPS (WAAS, ENGOS, MSAS): 0.05m/s
Time	50 ns RMS
Cold/Warm/Hot Start	36/33/1 sec, average
Dynamic Condition	
Altitude	<18,000m
Velocity	<515m/sec
Acceleration	<4g
Protocol	
GPS Output Data	NMEA 0183 (V3.01) -GGA, GSA, GSV, RMC (Default) VTG, GLL(Optional)
Baud Rate	115,200 bps
Power	
Built-in rechargeable Li-ion battery, Up to 48 hrs by dual power	
Bluetooth	
Standard	Fully compliant with Bluetooth V1.2
Bluetooth Profile	Serial Port Profiles (SPP), Up to 15 meters
Others	
Size / Weight	88.5 (L) X 56 (W) X 13.5 (H) mm/ 64g (battery included)
Operating Temperature	- 10 °C to + 60 °C
Storage Temperature	- 20 °C to + 60 °C
Charging	0 °C to + 45 °C

5. Hardware Introduction

5-1. Appearance

1. Power jack (mini USB type)
2. Power Button (ON/OFF/Enable LOG mode/Disable LOG mode)
3. Battery status LED (Red/Green)
4. Bluetooth status LED (Blue)
5. GPS status LED (Orange)
6. LOG status LED (Blue)
7. Internal antenna
8. Solar panel (Auxiliary power source)

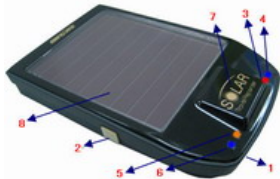

5-2. Hardware Function

Hardware Function	Description
Power Jack	Take the power cable and connect it to the power jack (mini USB type) for charging only
Power Button (On)	Press power button and hold for 3 sec to power BT-Q1200 on.
Power Button (Off)	Press power button and hold for 3 sec to power BT-Q1200 off
Power Button (Enable Log mode)	After power BT-Q1200 on, press power button once to enable log mode. Then BT-Q1200 would start logging with the blinking LOG status LED (blue).
Power Button (Disable Log mode)	Press power button again to disable log mode. The LOG status LED (blue) would be off, and stop logging.

5-3. Battery installation

- Put Battery in place:

1. Press the **PUSH** button on the bottom side of the unit

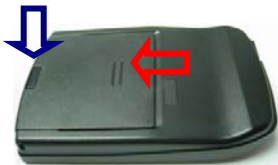

2. Pull out the battery cover. Insert battery in the unit



3. Put battery cover on to the cabinet. Then push down and force it forward to fit firmly



- Take Battery out:

1. Press the **PUSH** button on the bottom side of the unit

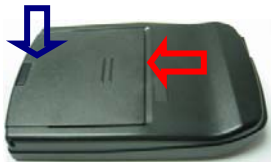

2. Pull out the battery cover and take out the battery from the unit.







- Charging your battery

For the first time using the BT-Q1200, please charge battery until it is fully charged. Take the power cable and connect it to the power jack (mini USB type) and recharge through USB cable, travel charger, or car cigarette adaptor. This will begin to charge the battery. Charging time is about 3 hours typically.



- When the Power LED is Red, battery power is low status. Please recharge.
- When the Power LED is Green, the battery is under charging mode.
- When the Power LED is blinking, the battery is fully charged.

5-4. LED Indicators

LED Status		Flash	ON	OFF
Power (Red/Green)		Low Power (Red) Fully charged (Green)	Recharging (Green)	
Bluetooth (Blue)		<u>Flash per 2 sec.:</u> Bluetooth connected and transmitting Mode <u>Flash per 5 sec.:</u> Power saving mode	Not connected /Pairing	GPS not powered
GPS (Orange)		<u>Flash per 1 sec.(Orange):</u> GPS position is fixed, Navigation	Detecting Satellite, GPS position not fix	GPS not powered
Log (Blue)		Enable Log mode		Disable Log mode

5-5. Function of Auto On-Off (Power saving mode)

BT-Q1200 supports **Auto On-Off** (Power saving mode). It can automatically enter sleeping mode after the Bluetooth connectivity is turned off, so the Blue LED will turn to flash every 5 seconds. Thus you can always power it on with very low power consumption.

Under power saving mode, when detecting Bluetooth is being connected, BT-Q1200 will auto wake up itself and the blue LED will turn to flash every 2 seconds and GPS Orange LED will be also On.

Note: Power saving mode would not function when log is enabled.

6. Setup BT-Q1200

6-1. Install USB Driver

NOTE:

The USB driver of BT-Q1200 only supports Microsoft Windows system (Win XP / Win Vista).

1. Please insert the Driver CD to your computer, and find the folder "USBDriver\Windows_2K_XP_S2K3_Vista". Double click "CP210xVPIInstaller.exe" to install the USB driver.

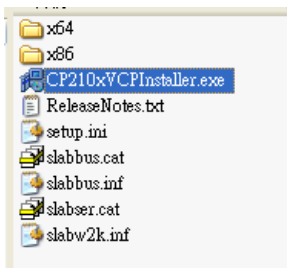

2. System would pop up the driver installation dialog. Please click <Install> to install the driver.

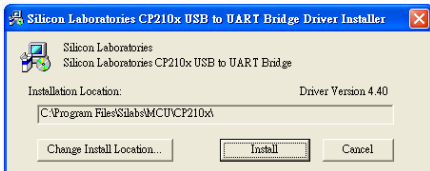

3. After completing the installation, please click <Yes> to restart your computer for taking effect of new setting. Driver installation dialog will show up. Please click <Install> to install the driver.

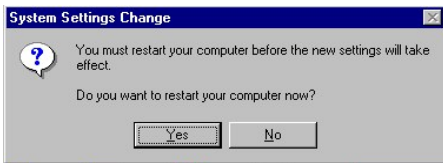

6-2. Install the software utility for BT-Q1200.

1. Please insert the Driver CD to your computer, and find the folder "Utility". Double click "setup.exe" to install the software utility.

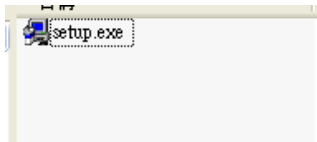

2. System would pop up the utility installation dialog. Please click <Next> for the next step.

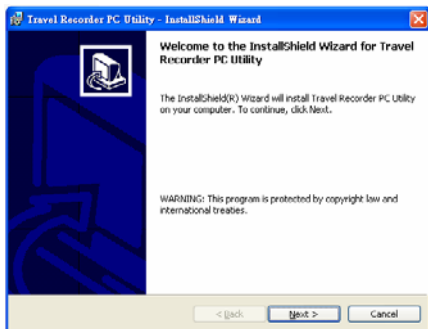

3. Please select “I accept the terms in the license agreement”, and then click <Next> to the next step.

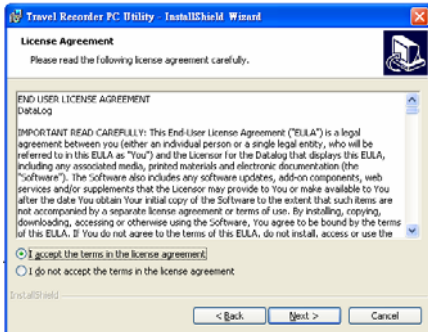

4. Please enter user name and organization and then click <Next> to the next step. (You can also click <Next> directly without any entry)

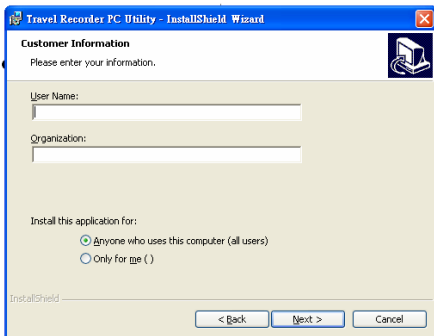

5. Please select “Typical” and then click <Next> to the next step.

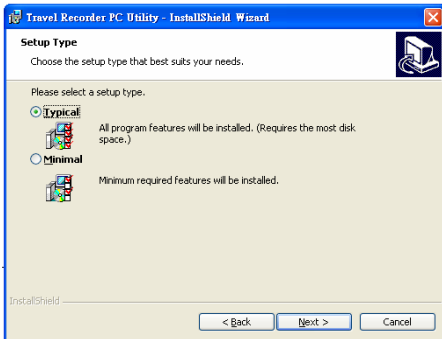

6. Check again if all the settings are correct. Then please click <Install> to start the utility installation.

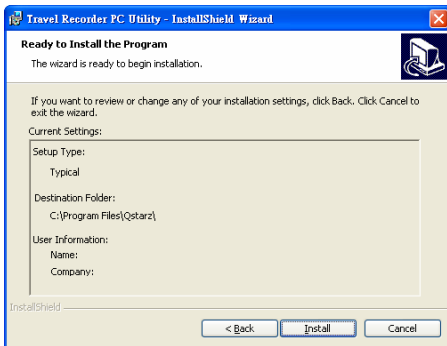

7. When the utility installation is completed, please click <Finish> to exit the installation dialog.

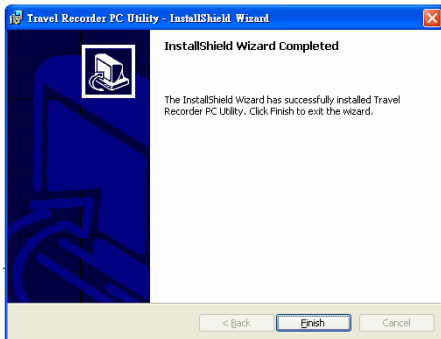

6-3. Install Google Earth

BT-Q1200 supports showing your travel path directly on Google Earth. Please go to <http://earth.google.com> for the free download of Google Earth, and then install it to your computer. For the operation procedure of Google Earth, please refer to <http://earth.google.com/support/>

7. Start to use

7-1. Fully charge the battery when using at the first time

A fully charged battery with solar power can last up to 48 hours continuously operation (under optimum conditions and sufficient light).

7-2. Connect BT-Q1200 with your PC

1. Please connect BT-Q1200 with your PC by mini USB cable.
2. Power on BT-Q1200 and switch it to start logging



3. Check the COM port no. your PC is assigned for BT-Q1200.

NOTE:

Before checking the COM port, please make sure USB driver has been installed properly.

- 3.1 Go to <Start> \ <Settings> \ <Panel Control> \ <Performance and Maintenance> \ <System>
- 3.2 Select <Hardware> tab and then click <Device Manager>
- 3.3 Expand the <Ports (COM & LPT)> and check "CP210x USB to UART Bridge Controller" to see which COM port is for BT-Q1200. (COM4 is for example)

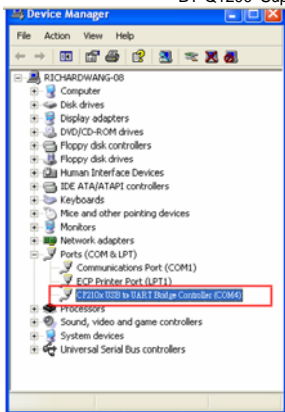

7-3. Start the software utility

NOTE 1:

Before starting the software utility, please make sure that the USB driver and the software utility has been installed properly. And also, make sure that BT-Q1200 is already connected to your PC by mini USB cable, power it on, and switch it to start logging or BT-Q1200 would enter sleep mode after few minutes.

NOTE 2:

PC Utility V3 only supports BT-Q1200. Any intention to use PC Utility V3 connecting GPS units other than BT-Q1200 would result in software disconnection automatically.

1. Click from <Start> \ <All Programs> \ <Qstarz Travel Recorder V3> \ Travel Recorder PC Utility V3.

2. < CONFIGURATION > \ <Connection>

Establish the communication between BT-Q1200 and your PC.

- 2.1 Click < CONFIGURATION > tab \ <Connection> button.
- 2.2 Select COM port (refer to 7-2, item 3) and set the baud rate to **115200**.
- 2.3 Click <Connect> button to establish the communication between BT-Q1200 and your PC.

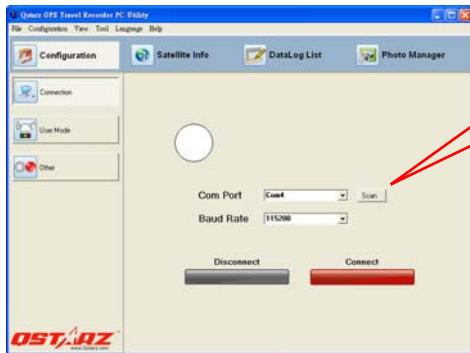

Click "Scan" button to search available COM port for your selection

3. < CONFIGURATION > \ <User Mode>

BT-Q1200 utility provides three user modes (Basic / Advanced / Professional) for your personal setting. You can complete the settings by each user mode per your requirement. Setup the user mode for your personal setting before logging your travel path.

NOTE 1:

The new setting has to erase all the data in the memory. During setting process, BT-Q1200 will stop logging and start logging again after setting completed.

NOTE 2:

- *Basic Mode usually is for your daily log.*
- *Advanced Mode can help you to measure the speed for your needs.*
- *If you need more detail information for the specific purpose, you can use*

Professional Mode to complete your settings.

- 3.1 Click < CONFIGURATION > tab \ <User Mode> button.
- 3.2 Select one of user modes (Basic / Advanced / Professional) for personal setting
- 3.2.1 **Basic Mode** provides simple setting for you. Select the transportation gear (Vehicle / Bicycle / Jog) you will use, and then click <SET> to set specific values to BT-Q1200. The detail is as following.

Basic Mode	AutoLog Option	Output Period	Log Format
Log for Vehicle (3 sec)	Log every 3 sec	GGA, GSA, GSV, RMC	UTC, VALID, LATITUDE, LONGITUDE, HEIGHT, SPEED, RCR, DISTANCE, NSAT, HDOP
Log for Bicycle (5 sec)	Log every 5 sec		
Log for Jog (10 sec)	Log every 10 sec		

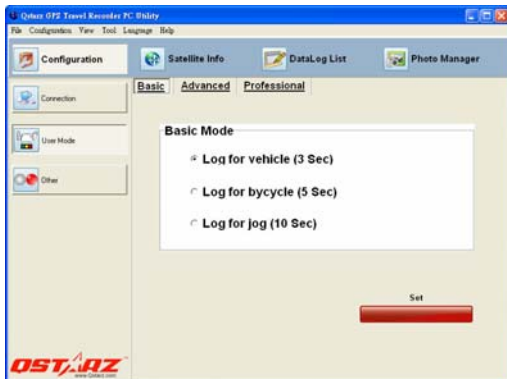

3.2.2 Advanced Mode let you setup two parameters. Select the transportation gear (Vehicle / Bicycle / Jog) you will use and you can modify the default value for your requirement, and then click <SET> to set the updating and specific value to BT-Q1200. The detail is as below.

Log for Vehicle

Advanced Mode	AutoLog Option	Output Period	Log Format
Log for Vehicle (Time + Speed)	Time: 1~999 (3 secs as default)	GGA, GSA, GSV, RMC	UTC, VALID, LATITUDE, LONGITUDE, HEIGHT, SPEED, RCR, DISTANCE, NSAT, HDOP
	Speed: 10~999 (60km/h as default)		
How BT-Q1200 log waypoints with the settings (3secs, 60 km/h)			
<ul style="list-style-type: none"> - When the speed is below 60km/h, BT-Q1200 would log one waypoint per 3 seconds. - When the speed is above 60km/h, it would log one waypoint per second. 			

Log for Bicycle

Advanced Mode	AutoLog Option	Output Period	Log Format
Log for Bicycle (Distance + Speed)	Distance: 10~9999 (40m as default)	GGA, GSA, GSV, RMC	UTC, VALID, LATITUDE, LONGITUDE, HEIGHT, SPEED, RCR, DISTANCE, NSAT, HDOP
	Speed: 10~999 (25km/h as default)		
How BT-Q1200 log waypoints with the settings (40m, 25 km/h)			
<ul style="list-style-type: none"> - When the speed is below 25km/h, BT-Q1200 would log one waypoint per 40 meters. - When the speed is above 25km/h, it would log one waypoint per second. 			

Log for Jog

Advanced Mode	AutoLog Option	Output Period	Log Format
Log for Jog (Distance +	Distance: 10~9999 (30m as default)	GGA, GSA,	UTC, VALID, LATITUDE,

Speed)	Speed: 10~999 (10km/h as default)	GSV, RMC	LONGITUDE, HEIGHT, SPEED, RCR, DISTANCE, NSAT, HDOP
<p>How BT-Q1200 log waypoints with the settings (30m, 10 km/h)</p> <ul style="list-style-type: none"> - When the speed is below 10km/h, BT-Q1200 would log one waypoint per 30 meters. - When the speed is above 10km/h, it would log one waypoint per second. 			

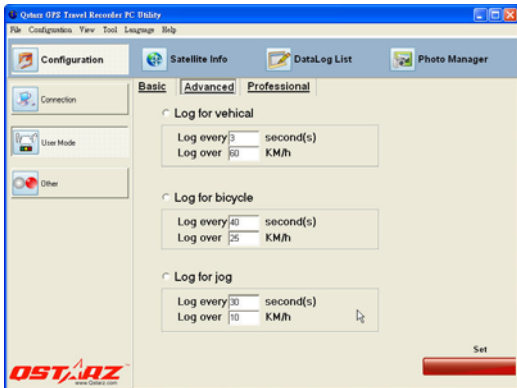

3.2.3 Professional Mode provides three sections for your detailed settings manually, including Output Period, AutoLog Option, and Log Format. After complete all settings, click <SET> to set the values to BT-Q1200. The detail is as below.

(1) Output Period

- Description

1. NMEA setting here only affects the NMEA sentences for navigation. There's nothing to do with data recording.
2. The default settings: GGA, GSA, GSV, RMC
3. Check the checked box of GLL, VTC, ZDA to enable the protocol.

- Adjust the Period (s) for sentence update rate (For example, GLL (3) means GLL sentence is updated per 3 seconds).

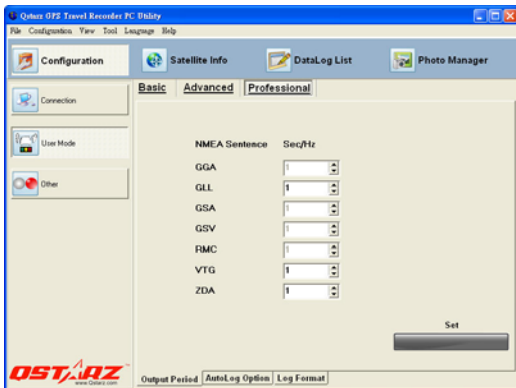

(2) AutoLog Option

- Description

- Provide three conditions (Time, Distance, Speed) for setting your log interval.
- Support multi-settings (Time+Distance+Speed) for your log interval.
- Time interval is between 1~999 second(s).
- Distance interval is between 10~9999 meters.
- Speed interval is between 10~999 km/h.



- How BT-Q1200 log waypoints with different settings

AutoLog Setting	Description
Log every X seconds	BT-Q1200 would log one waypoint per X seconds.
Log every Y meters	BT-Q1200 would log one waypoint per Y meters.
Log over Z km/h	When the speed is above Z km/h, it would log one waypoint per second.
1. Log every X seconds 2. Log every Y meters	BT-Q1200 would log one waypoint per X seconds or per Y meters, depends on which condition meets the setting (distance / time) first.
1. Log every X seconds 2. Log over Z km/h	<ul style="list-style-type: none"> - When the speed is below Z km/h, BT-Q1200 would log one waypoint per X seconds. - When the speed is above Z km/h, it would log one waypoint per second.
1. Log every Y meters 2. Log over Z km/h	<ul style="list-style-type: none"> - When the speed is below Z km/h, BT-Q1200 would log one waypoint per Y meters. - When the speed is above Z km/h, it

	would log one waypoint per second.
1. Log every X seconds 2. Log every Y meters 3. Log over Z km/h	<ul style="list-style-type: none"> - When the speed is below Z km/h, it would log one waypoint per Y meters or per X seconds, depends on which condition meets the setting (distance / time) first. - When the speed is above Z km/h, it would log one point per second.

(3) Log Format

- Description

1. Setup which information you want to record for each logging point.
2. The default recording fields are UTC, VALID, LATITUDE, LONGITUDE, HEIGHT, SPEED, RCR, and DISTANCE.

- The table of Format Type

Format Type	Item	Description
UTC	Date/Time	Universal Coordinated Time, formerly GMT or Greenwich Mean Time.
	Mili-second	Mili-second
Fix Mode	VALID	Data fix or not
Navigation	Latitude	A north/south measurement of position perpendicular to the earth's polar axis.
	Longitude	An east/west measurement of position in relation to the Prime Meridian, an imaginary circle that passes through the north and south poles.
	Height	The altitude of a place above sea level or ground level.
	Speed	Rate of motion
	Heading	The compass direction in which the longitudinal axis of a ship or aircraft

		points
Differential Data	DSTA	DGPS station ID number
	DAGE	Time in seconds since last DPGS update
DOP	PDOP	(Positional Dilution Of Precision) ; Position accuracy; 3D-coordinates
	HDOP	(Horizontal Dilution Of Precision); horizontal accuracy; 2D-coordinates
	VDOP	(Vertical Dilution Of Precision); vertical accuracy; height
Method	RCR	Record method: Speed/ Time/ Distance/ POI Button
Satellite Information	NSAT	Number of Satellite (in Used, in View)
	SID	Satellite ID
	Elevation	The elevation of the satellite
	Azimuth	Line-Of-Sight angle of the satellite
	SNR	Signal to Noise Ratio
Other	Distance	The distance between two logging points



4. < CONFIGURATION > \ <Other>

Setup the recording method for the flash memory of BT-Q1200 under <Other>.

- 1.1 Click <CONFIGURATION> tab \ <Other> button.
- 1.2 The default setting is <Stop>. When the flash memory is full, BT-Q1200 will stop logging data. If you want to record new data, you must erase all data in the flash memory.
- 1.3 Click <Overwrite> to change to Overwrite method. Then system will pop up a message box to notify you "Overwrite is set". When the flash memory is full, BT-Q1200 will overwrite the memory data. So the previous data will be updated as newer.



5. <SATELLITE INFORMATION>

Display the current satellite viewer of your BT-Q1200 at < SATELLITE INFORMATION > tab.

- 1.1 Click <SATELLITE INFORMATION> tab
- 1.2 Please review the detail description of satellite information as below.

Item	Description
Date	UTC date
Time	Universal Coordinated Time, formerly GMT or Greenwich Mean Time.
Mode	(3D Fix/ 2D Fix/ No Fix)
TTFF	Time to first fix
Latitude	A north/south measurement of position perpendicular to the earth's polar axis.
Longitude	An east/west measurement of position in relation to the Prime Meridian, an imaginary circle that passes through the north and south poles.

Speed	Rate of motion
PDOP	(Positional Dilution Of Precision) ; Position accuracy; 3D-coordinates
HDOP	(Horizontal Dilution Of Precision); horizontal accuracy; 2D-coordinates
VDOP	(Vertical Dilution Of Precision); vertical accuracy; height

- 1.3 Click <Hot> / <Warm> / <Cold> button to perform hot/warm/cold start immediately.

Item	Description
<Hot> button	Perform hot start
<Warm> button	Perform warm start
<Cold> button	Perform cold start

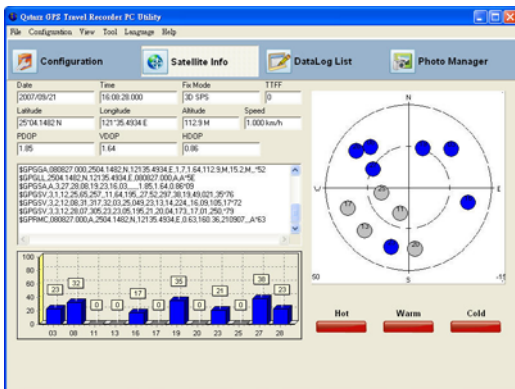

6. <DATA LOG LIST>

Access the log data which is downloaded from BT-Q1200.

NOTE 1:

Before accessing your log data of BT-Q1200, please establish the communication between BT-Q1200 and PC with mini USB cable. (Refer to 7-3, item 2)

NOTE 2:

Please install Google Earth before trying to download and draw map on Google Earth. (Refer to 6-3)

6.1 Click <DATA LOG LIST> tab.

6.2 Click <Download> button to download the log data from BT-Q1200. System will pop up a dialog box for asking to save the log file. After selecting a location to save, a message box pops up to show the progress status. It will take a few minutes depending on the data volume. After completing the log data downloading, those data will be shown on data grid.



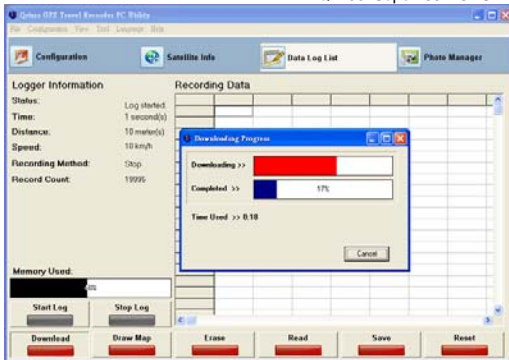

- 6.3** Click <Draw Map> button to display your log data on Google Earth. System will pop up a dialog box for setting the data period and drawing type. After click <OK> button, system will export the log data into Google Earth to display your travel path.



6.4 Your travel path will be shown on Google Earth as the following image. You can check the detail information for each log point.

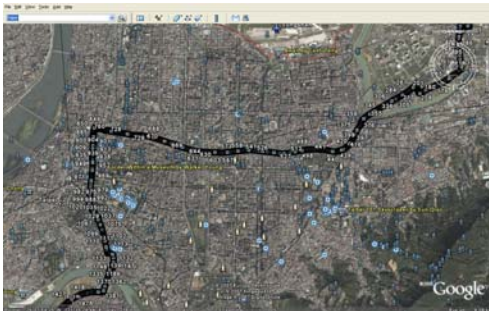

6.5 Please review the other function at <DATA LOG LIST> as below.

Item	Description
<Start Log> icon	Display Log status (Activation with red highlight)
<Stop Log> icon	Display Log status (Activation with red highlight)
<Download> button	Download the log data from BT-Q1200. System will pop up a dialog box for saving the log file. After selecting a location to save, a message box pops up to show the progress status. It will take a few minutes depending on the data volume. After completing the log data downloading, those data will be shown on data grid.
<Draw Map> button	Show your log data on Google Earth.
<Erase > button	Clear all log data from the flash memory of BT-Q1200.
<Save > button	Save the logged data in the memory of BT-Q1200 into your PC. It supports CSV file, GPS file, NMEA file, Google Earth file, PLT file, and Text file format.
<Read> button	Open log file that saved as before
<Reset> button	Reset your BT-Q1200 and reload to factory setting.

7. <Photo Manager>

Allow you to manage the log files downloaded from BT-Q1200, combine GPS data with photos by Geotagging, and create KMZ file supported by Google Earth.

7.1 Click < Photo manager > tab \ <GPS Log Manager> button.

7.1.2 On the "GPS Log Files" column is the log files from default location on the hard-disc (C:\Program Files\Qstarz\Travel Recorder PC Utility V3). You can add, delete, and delete all by clicking right button of mouse to show the function menu and executing each function.

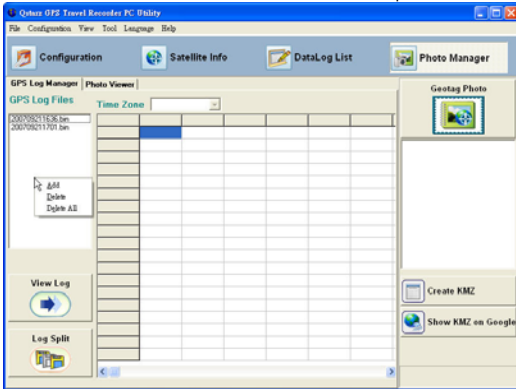

7.1.3 Select one log file from “GPS Log File” column and then click <View Log> to show the log data on data grid.

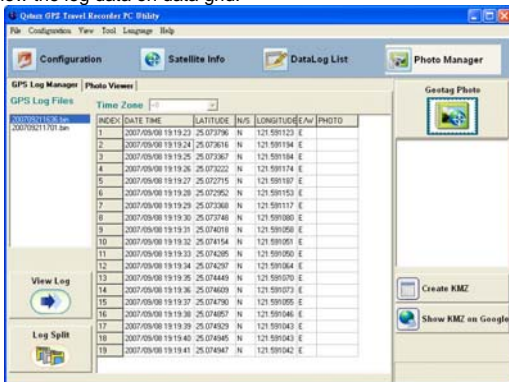

7.1.4 Adjust the shown time by selecting time zone according to the local time

Note: all the date/time data is recorded as Greenwich time.

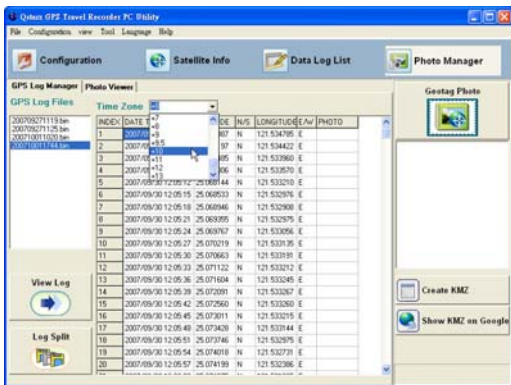

7.1.5 Click <Log Split> button to split the log file you select. System will pop up a function window allowing you to do the split procedure.

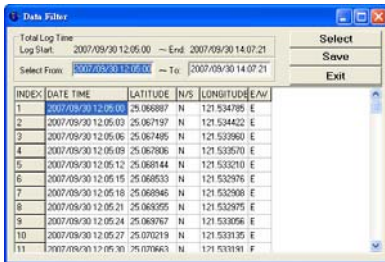

7.1.6 Input a time range on “Select from: ~ To:” you want to keep and click “Select” to include these data range, and then click “Save ” to save the split log file.

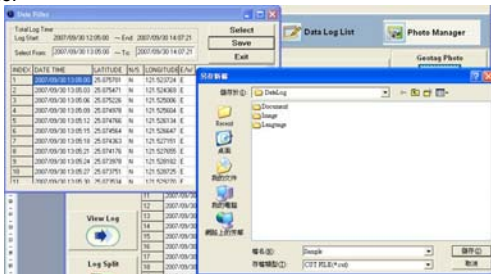

7.2 Click <Photo Manger> tab \ <Photo Viewer> button

Please select path of image file on the left side. The file names would appear below and preview of the file would appear on center.

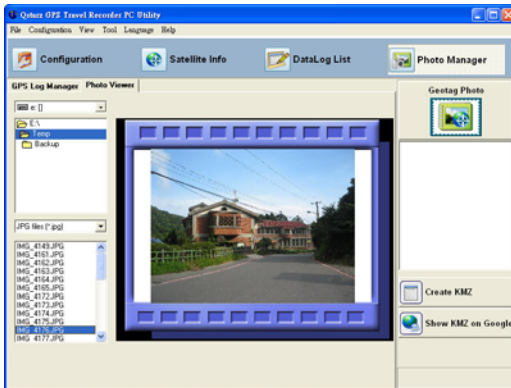

7.3 Click <Geotag Photo> button to start Geotagging the photos. System will automatically geotag photos with GPS position data if one has the same time as the other.

Note: Before Geotagging, please make sure to select the log file and corresponding photos.

7.4 Click <Create KMZ> button to create KMZ file supported by Google Earth after geotagging photos.

Note: The processing time depends on the performance of your computer and the number and image size of your pictures. To accelerate the process, it may suggest to adjust the image resolution before creating KMZ file.

7.5 Click <Show KMZ on Google> button to show the KMZ file you just created on Google Earth.

8 <Toolbar>

8.1 <File> \ <Exit> exit the program

8.2 <Configuration> \ <Connection> refer to 7-3, item 2
<Configuration> \ <User Mode> \ <Basic> <Advanced> <Professional> refer to 7-3, item 3
<Configuration> \ <Other> refer to 7-3, item 4

8.3 <View> \ <Satellite information> refer to 7-5

8.4 <Tool> \ <Data Log List> refer to 7-6
<Tool> \ <Photo Manager> refer to 7-7
<Tool> \ <Option> you can adjust the way to show speed format and time zone where you are located here.

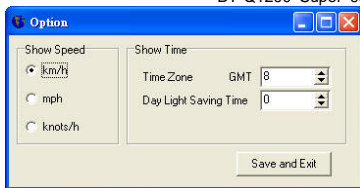

<Tool> \ <Security> Enable the security function to protect your setting from unauthorized modification.



8.5 <Language> Nine languages supported allow you to change language instantly depending on your preference, including Chinese Traditional, Chinese Simplified, English, German, Japanese, French, Italian, Portuguese, and Spanish.

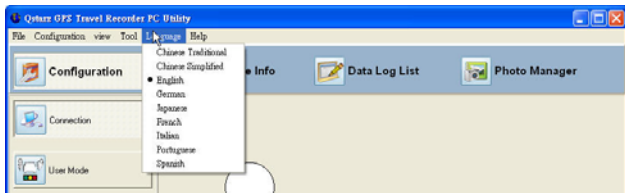

- 8.6 <Help> \ <Document> display the user manual.
<Help> \ <About> display the software detail information.



8. Useful reference Applications on the internet

8-1. locr GPS Photo

BT-Q1200 is the member of locr GPS Photo certified product. This utility can integrate travel log and digital photos by date/time to show your photos on the map directly.

After the integration, the current GPS coordinates also can be imported to your digital photos for the further application. Please find the installation file for Windows XP/Vista or Symbian system in Qstarz GPS CD. Go to <http://www.locr.com> for the further information.

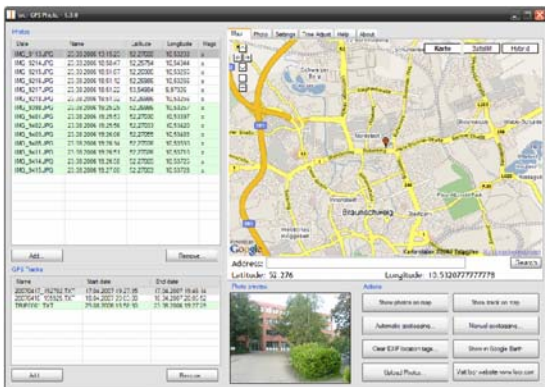

8-2. GPSTbabel

This utility can transfer your NMEA file to GPX file or other format. Please go to <http://www.gpsbabel.org> for free download.

1. Select "NMEA 0183 sentences"

2. Open your NMEA file

3. Select "GPX XML"

4. Enter your GPX file name

5. Click "let's go" to transfer

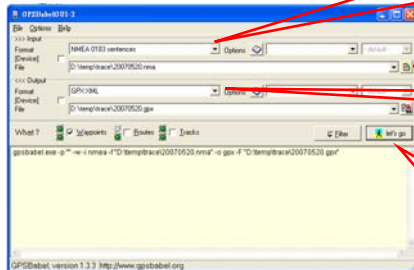

8-3. SPORTSMATE

This web site can share your travel log with your friends. Before sharing your trip, please apply a new account first. Please go to <http://www.tsm.com> for the further information.

SPORTSMATE TRIP TRACKER

Home | **Trips** | Webshop | Information | Support

Login Remember me
 Email address

Trip 080307

- Trip information**

User	Michel Brinkman
Duration	01:00:54
Distance	10.01 km
Trip date	08-03-2007
Start time	21:36
Start city	Apeldoorn
End city	Apeldoorn
- Statistics**

Print this trip

Minimap

Graph

Speed (km/h) | Height (m)

Posted by: Michel Brinkman | Posted at: 12-03-2007 23:05
 Website: No website available

8-4. JetPhoto Studio

This utility can integrate travel log and digital photos by date/time to show your photos on the map directly. After the integration, the current GPS coordinates also can be imported to your digital photos for the further application. Please go to <http://www.jetphotosoft.com> for free download.

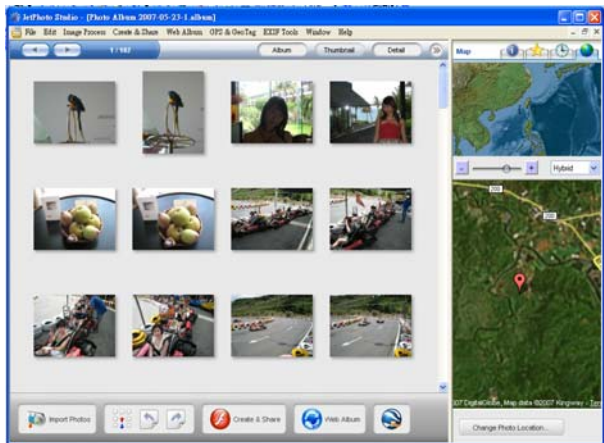

8-5. VeoGeo

This website allows you to combine travel log and video by date/time to show your video on the map directly. Please go to www.veogeo.com for further information and register for a free new account.

[Login](#) [Register](#)

VeoGeo beta
[Browse](#)
[Blog](#)
[Forum](#)
[Upload](#)

[Advanced Search](#)

CityCat - Downstream - Brisbane

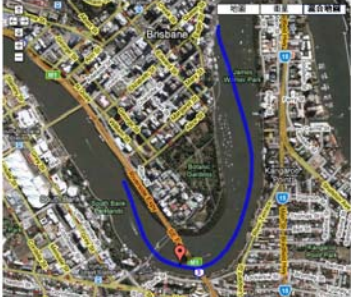



0:02:20 of 0:07:13

Current Speed: 11.77 km/hr (7.31 miles/hr)

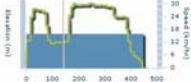

Ads by Google

Mountain Hiking Alps
 Wide number of local cycling paths
 Beautiful nature
www.brisbane.info

Mountain Bike Accessories
 Buy Now 15% Off Your 1st Purchase
 Free Shipping Today Huge Savings
www.vegoes.com

Prescription Sunglasses
 for cyclists Wrap Rx specialists
www.eyeglasses.com

Outdoor Instructor Courses

9. Trouble Shooting

Question	Answer
Can BT-Q1200 be used to navigate when travel log is on?	Yes, you can use BT-Q1200 to navigate when travel log is on simultaneously.
I lost my travel charger and battery. Where can I find replacements for both?	DC Input range of BT-Q1200 is 4.5~5.5V. You can use a travel charger which support DC output range from 4.5~5.5V. You can also use a common mini USB cable to charge your unit via the laptop. Besides, The battery for BT-Q1200 is compatible with Nokia N73. The battery model is BP-6M.
How can I know if my memory is full?	If you see the orange GPS light turns from orange to solid blue, that means the memory is full.
I noticed that the internal clock time is 1 hour behind, how can I do?	There is no internal clock delay; it is UTC time (Greenwich time) that confused you. For local time, you can adjust under <Tool> \ <Option> and see the local Date/Time under "Satellite Information" tab of utility.
Can the logged data be downloaded by Bluetooth?	So far Bluetooth function is not a standard component on laptop. So we didn't perform the download via Bluetooth interface. BT-Q1200 is designed to download data via USB interface.
My BT-Q1200 could not use 32 hours?	BT-Q1200 can use 48 hours under the optimum environment. GPS would need more power consumption when keep trying a position fix, seeking Bluetooth connection, or under an unstable environment (bad weather, forest, buildings). Those would take GPS more calculation and power consumption. So it would spend more power consumption. After the red LED light is blanking, it still can be used for your navigation without any problem.

10. Appendix

Navigate as a Bluetooth GPS Receiver with Handheld devices

10-1. Activate the Bluetooth function in your PDA/Smart phone or PC

Before activating the Bluetooth function in your PDA/PC, please switch BT-Q1200 to <NAV> position for pairing and check if your device is equipped with Bluetooth function. If not, you may need to acquire an optional CF/SD Bluetooth card or Bluetooth dongle.

NOTE 1:

BT-Q1200 would be identified as "iBT-GPS" under Bluetooth Manager. In further use, you just need to click it to connect to this GPS Travel Recorder.

NOTE 2:

The pairing procedure is required to execute in the first time only. And the pass code is "0000" if required.

NOTE 3:

Select correct com port and baud rate : 115200 under your navigation software (Most of navigation software can auto-detect Bluetooth Com port, so you do not need to setup manually).

10-2. Create Bluetooth Setting (Windows Mobile 5 for Pocket PC)

1. Switch your Bluetooth Receiver on.
2. Tap the Bluetooth icon at the bottom.



3. Check "Turn on Bluetooth".



4. Tap the “Devices” tab, and then tap “New Partnership”.



5. System will search for all Bluetooth devices.

6. Select “iBT-GPS” device, and tap “Next”.



7. Enter Passkey “0000” if required, and then tap “Next”.



8. Check “Serial Port”, and then tap “Finish”.



9. The “iBT-GPS” device will be established in the list.



10. Tap the “COM Ports” tab, and select “New Outgoing Port”.



11. Select the “iBT-GPS”, and then tap “Next”.



12. Uncheck “Secure Connection”, and select a COM port (for example, COM 8) from the “Port:”. Then tap “Finish”.



13. The “iBT-GPS” with its COM port will be shown on the list.



10-3. Start your navigation software

Activate your navigation software and make sure to select the correct “COM Port”.

NOTE 1:

In the map software such as TomTom, you might need to change preference and set “Other Bluetooth GPS Device” according to PDA/phone model. In some case please consult map software company to vary the setting if you have issue on positioning.

NOTE 2:

There might be specific setting requirement per navigation software. Such as Tomtom, please delete other GPS settings under Tomtom software, and keep one only.

10-4. Safety Notices

R&TTE / CE Notice

This device is confirmed to comply with the requirements set out in the Council Directive on the Approximation of the Laws of the Member States relating to Electromagnetic Compatibility (89/336/EEC), Low-voltage Directive (73/23/EEC) and the Amendment Directive(93/68/EEC), the procedures given in European Council Directive 99/5/EC and 89/336/EEC.

The equipment was passed. The test was performed according to the following European standards:

EN 300 328-2 V.1.2.1 (2001-08)

EN 301 489-1 V.1.4.1 (2002-04) / EN 301 489-17 V.1.2.1 (2002-04)

EN 50371: 2002

EN 60950: 2000

FCC Notice

This device complies with part 15 of the FCC rules. Operation is subject to the following two conditions:

1. This device may not cause harmful interference.
2. This device must accept any interference received, including interference that may cause undesired operation.

Spec. is subject to change without prior notice.

All rights reserved. All registered trademark is belong to their respected companies.